

A black Aqua Barista water dispenser with a Primo Water logo and a control panel. The top lid is open, revealing a green filter. The control panel has a digital display and several buttons. The dispenser has two water taps, one red and one blue, and a 'Replace Bottle' button. The background is split into orange and blue sections.

# aqua barista® User's Manual

**IMPORTANT:** This manual includes important safety material; please read all instructions before plugging power supply cord into receptacle.

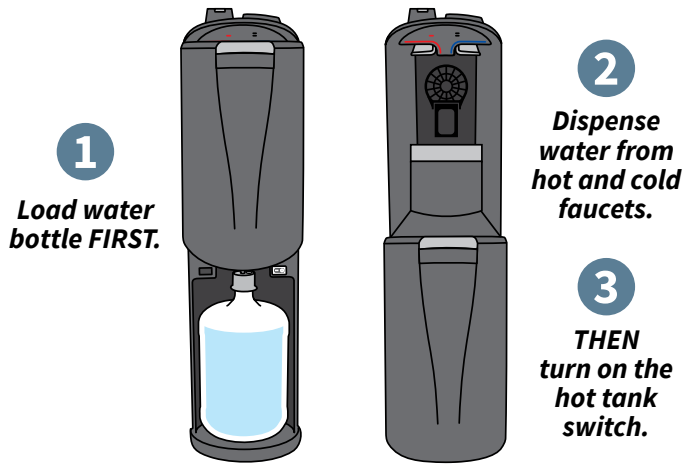

**STOP & READ DIRECTIONS before plugging in dispenser.**

Read complete **HOW TO INSTALL** instruction sequence before plugging in and turning on dispenser. Failure to follow proper installation instructions may cause damage to water dispenser.

**SAFETY PRECAUTIONS**

Basic safety precautions should be followed when using electrical appliances, including:

- Only plug in dispenser in the sequence the manual indicates (see HOW TO INSTALL AND USE).
- In accordance with these instructions, the dispenser must be properly located and installed before use (see HOW TO INSTALL AND USE).
- Use only bottled water in the dispenser.
- Do not use with water that is microbiologically unsafe or of unknown quality.
- Keep all flammable liquids or vapors away from all appliances.
- Dispenser must be unplugged before cleaning, sanitizing or repairing (see CLEANING AND SANITIZING).
- Wipe up any water spills immediately after loading or unloading water bottles.
- The dispenser heats water to a temperature above 196° F (91.5° C). Water temperatures above 125° F (52° C) can cause severe burns or death from scalding. Most at risk of being scalded are children, the disabled and the elderly.
- Ensure the dispenser stands upright for 2 hours before loading water bottle, plugging in and turning unit on.
- Always lift dispenser by handle located on rear of unit. Lifting dispenser by faucet or faucet levers will damage the unit.
- Follow proper grounding safety precautions and instructions prior to plugging in the unit (see GROUNDING SAFETY PRECAUTIONS AND INSTRUCTIONS).
- Do not use an extension cord.
- Supervise children when using the dispenser (see CHILD SAFETY).

**⚠ WARNING: Do not remove drain plug from the hot tank.**

**GROUNDING SAFETY PRECAUTIONS AND INSTRUCTIONS**

**⚠ WARNING: The dispenser must be grounded – if the appliance is improperly grounded, the result could be electric shock. Do not immerse cord, plug or any other part of the dispenser in water or other liquids.**

Ensure that the available power supply matches the dispenser’s voltage specifications indicated on the nameplate label (located at the rear). Please ensure that dispenser is set up so access to the power outlet and plug is unobstructed.

**💡 IMPORTANT: To provide additional protection from the risk of shock, the dispenser MUST be connected to a ground fault circuit interrupter (GFCI) outlet at all times. Use of an extension cord will void any warranties.**

If the supply cord is damaged, it must be replaced by a special cord or assembly available from the manufacturer or its service agent.

Always grasp plug and pull straight out from outlet. Never unplug by pulling on power cord.

## CHILD SAFETY

**⚠ CAUTION: Supervise children when using the dispenser.**

The hot dispenser faucet is equipped with a child safeguard that reduces the risk of hot water being dispensed accidentally or by small children. To dispense hot water, simultaneously depress the child safety lock (located above the left hot faucet lever) and the left hot faucet lever. Do not allow children to hang, climb or stand on the dispenser; the dispenser could fall over and the child could be injured.



## RECEIVING

Inspect the dispenser box carefully for any evidence of shipping or handling damage before signing to receive goods. In case of shipping damage, claims should be filed immediately with the carrier.

## HOW TO INSTALL AND USE

**⚠ WARNING: Read through every step in HOW TO INSTALL AND USE before plugging in or turning unit on. Do not turn on the hot tank switch until completing step #15. Failure to follow the installation steps in order could cause a hot tank failure.**

1. Install dispenser on a level floor strong enough to support it when fully loaded.
2. Ensure dispenser stands upright for a minimum of 2 hours before loading water bottle, plugging in and turning on dispenser.
3. Place dispenser a minimum of 4 inches away from the wall to ensure ventilation.
4. Do not install dispenser where it will be subject to direct sunlight, heat or moisture.
5. Do not install dispenser where the temperature will go below 50° F (10° C) or above 100° F (38° C).
6. Wipe down the water bottle cap and neck to ensure there is no debris.
7. Open dispenser door by sliding door upward to allow access to bottle area.
8. Place fresh bottle outside of the cabinet.

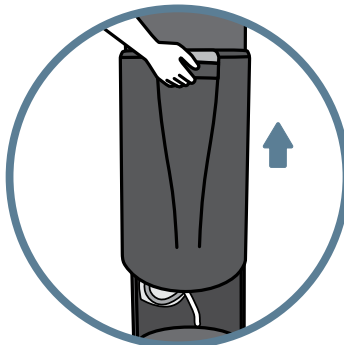

9. Remove bottle cap sticker completely from the top of the bottle.

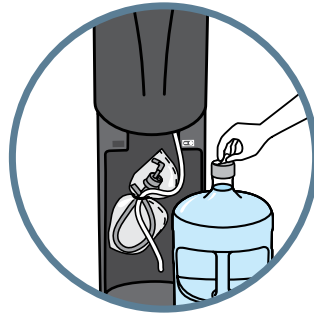

10. Unpackage the bottle adaptor from the bag inside the cabinet. Remove the protective red cap from the SmartFlo™ Water System hose. Insert the hose into the bottle adaptor cap.

**NOTE:** Touching the bottle adaptor assembly pieces with bare hands could cause contamination. Be sure to wash hands prior to assembling or use sterile gloves when handling bottle adaptor assembly pieces.

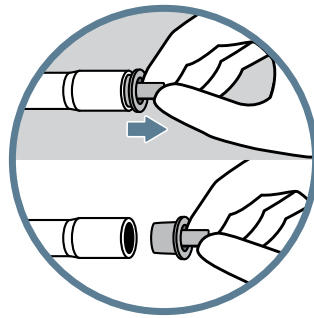

11. Place the bottle adaptor probe into the bottle.

**NOTE:** Insert bottle adaptor tubing into bottle as quickly as possible to ensure proper sanitization is maintained. Do NOT turn on the hot tank switch yet.

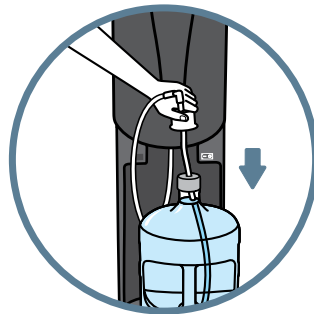

12. Slide the bottle adaptor over the neck of the bottle, ensure tube hits the bottom of bottle and push down to secure.

13. Slide bottle into cabinet and slide door downward to close.



14. Install drip tray.



15. Plug in dispenser and prime water system. Prime water system by first depressing the cold water lever for approximately 1 minute (or until water begins to flow from the faucet) and then depressing the hot water lever for approximately 1 minute (or until water begins to flow from the faucet).



16. Activate heating function by turning on the hot tank switch located inside the sliding door.

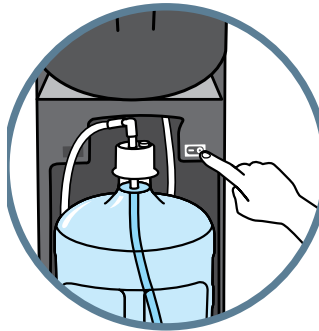

17. Dispense and dispose of at least 1 quart of water prior to drinking any water.

**NOTE:** It takes approximately 15 to 20 minutes for hot water to reach optimum temperature and several hours for cold water to reach optimum temperature.

## REPLACING BOTTLE

1. Open cabinet door.
2. Place new bottle outside of cabinet.
3. Remove empty bottle from cabinet.
4. Remove bottle cap sticker completely from the top of the bottle.
5. Remove the bottle adaptor assembly from the empty bottle and place the bottle adaptor assembly into the new bottle.

**NOTE:** Do NOT touch the bottle adaptor tubing. Remove the bottle adaptor assembly and install the bottle adaptor assembly by grabbing the cap only. Place the bottle adaptor into the new bottle immediately to avoid contaminating the bottle adaptor tube.

## BREWING INSTRUCTIONS

**⚠ WARNING: Always use caution when handling hot water.**

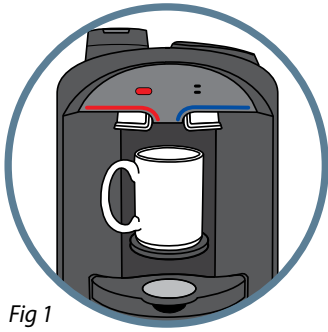

Fig 1

1. Place coffee cup on cup holder (Fig 1).



Fig 2

2. Lift silver handle and place K-Cup® pod into holder (Fig 2).

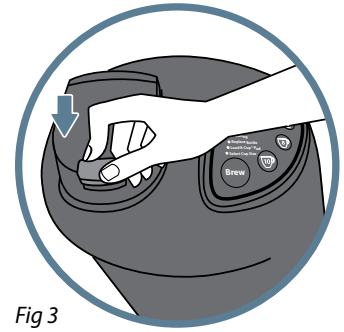

Fig 3

3. Pull down on silver handle until locked (Fig 3).

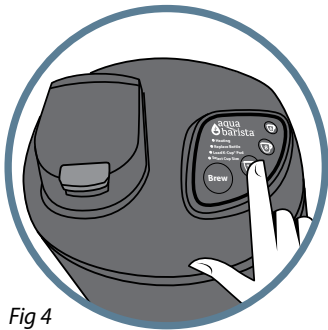

Fig 4

4. Select cup size (Fig 4).



Fig 5

5. If Brew light is solid, press button and coffee will brew. If dispense light is not lit, water has not reached optimum brewing temperature. Wait for the light indicator to turn solid, and then press button to brew (Fig 5).



Fig 6

6. Once the brew cycle is complete, open handle to remove brown coffee pod holder. Discard empty K-Cup® pod but do not discard the coffee pod holder. Place the brown coffee pod holder back in place for the next user (Fig 6).

## CLEANING AND SANITIZING

Your water dispenser exterior should be thoroughly cleaned at least twice a year, and your SmartFlo™ cartridge replaced every 6 months.

**NOTE:** Areas with high TDS/mineral content water will require the SmartFlo™ cartridge to be changed more frequently than in areas with low/no TDS/mineral content.

If you do not have a replacement cartridge handy, you can order one [here](#) and it will be shipped directly to you. Your replacement kit will include a SmartFlo™ cartridge, bottle adaptor, lid key and plug for the bottle tube:

Before you start cleaning, wash your hands thoroughly with soap and water for at least 20 seconds.

**TIP:** The best time to replace your water cartridge is when the existing water bottle is empty.

### WHAT YOU'LL NEED:

- SmartFlo™ replacement cartridge (if replacing)
- 70% rubbing alcohol or food surface approved disinfecting wipes
- Clean cloth or soft brush
- Disposable non-latex gloves
- Bucket
- Heat-resistant container to fit under spigots (i.e. coffee mug)
- Towels to absorb any water spills

**If not replacing the SmartFlo™ cartridge, skip to steps 20-22**

**WARNING:** Always use caution when handling hot water.

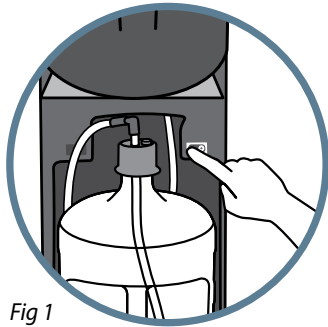

Fig 1

1. Slide the cooler door up and turn off the hot tank switch (Fig 1). Let the unit stand for one hour before cleaning to allow the hot tank to cool.

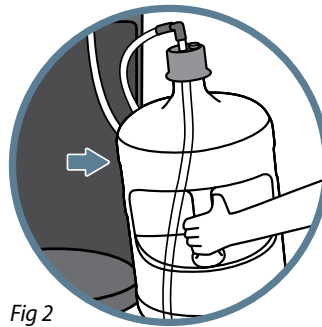

Fig 2

2. Remove the empty water bottle (Fig 2). Wipe interior cabinet with 70% rubbing alcohol or food surface approved disinfecting wipes.

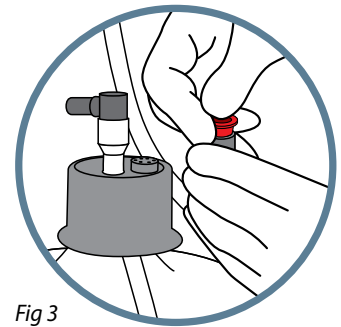

Fig 3

3. Unplug the bottle tube connected to the neck of the water bottle. Plug the bottle tube using the red plug provided in the SmartFlo™ replacement kit (Fig 3).

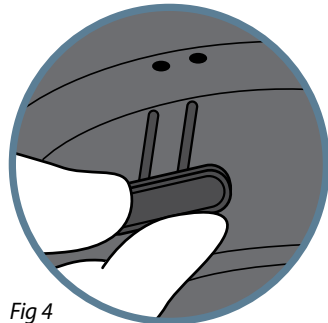

Fig 4

4. Remove cup holders, if applicable. Open the cooler lid using the key provided in the replacement kit (Fig 4).
5. Close cooler door. Place a glass or other container below the water faucets to catch any drips.

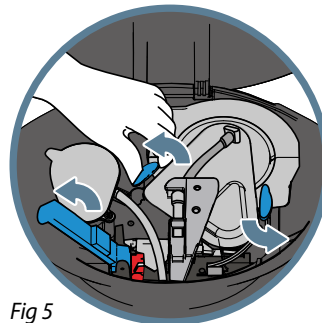

Fig 5

6. Remove the SmartFlo™ cartridge and bottle tube by unlatching the blue locking arm and rotating the two blue knobs to the open position (Fig 5).

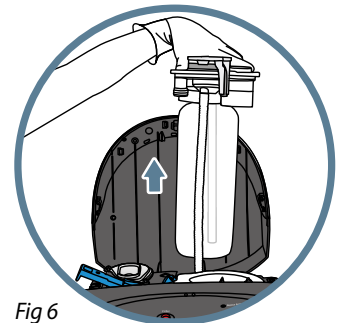

Fig 6

7. Pull up on the SmartFlo™ water cartridge (Fig 6). Do not squeeze the water reservoir as water could leak out.

**TIP:** Have a bucket nearby to dispose of the used SmartFlo™ cartridge and bottle tube, which will contain water.

**NOTE:** If SmartFlo™ cartridge doesn't move when pulling up, unplug the dispenser from the wall outlet and wait 5 minutes. Then plug the dispenser back in.

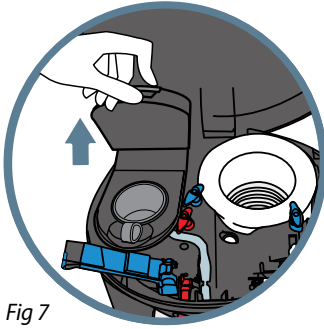

Fig 7

- With the cooler top still open, open the K-Cup® pod assembly lid (Fig. 7).

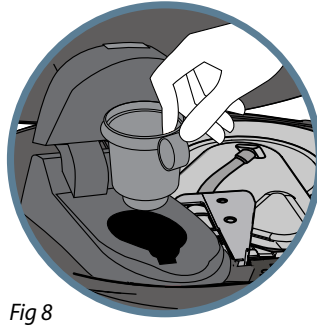

Fig 8

- Remove the brown K-Cup® pod holder (Fig 8) and machine wash (top rack only).

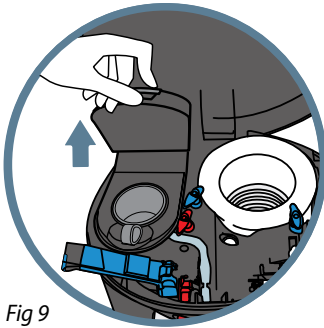

Fig 9

- Turn the red twist locks on each side to release the front K-Cup® cafe assembly. (Fig. 9).

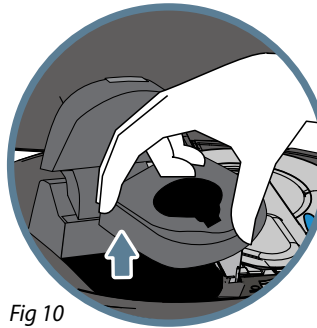

Fig 10

- Lift out and machine wash (top rack only) (Fig. 10).

**⚠ WARNING:** There are two sharp needles that puncture the K-Cup® pod, one above the K-Cup® Pod Holder and the other in the bottom of the K-Cup® Pod Holder. To avoid risk of injury, do not put your fingers in the K-Cup® Pod Assembly Housing.

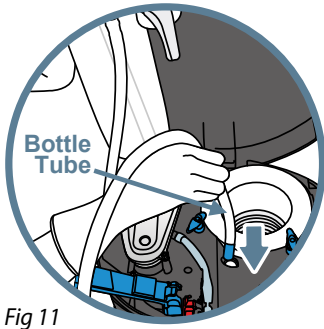

Fig 11

- Wearing gloves, feed the new bottle tube through the hole indicated (Fig 11).

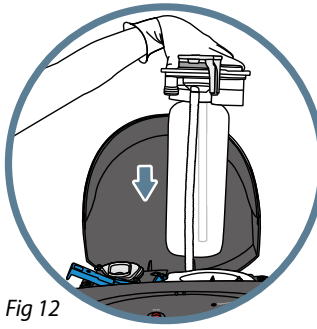

Fig 12

- Insert the new SmartFlo™ cartridge and secure into place by pressing down (Fig 12).

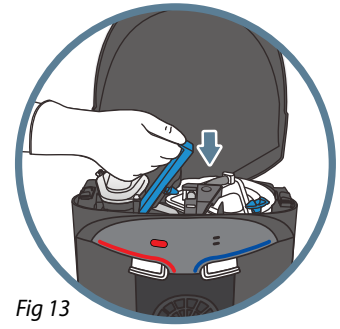

Fig 13

- Rotate the blue knobs to the closed position. Close and latch the blue locking arm (Fig 13).
- Close the cooler lid by pushing down to lock into place.



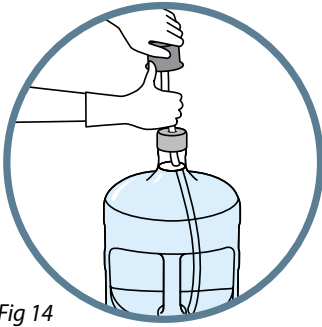

Fig 14

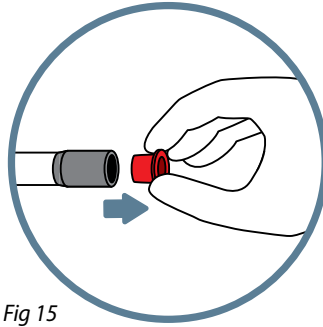

Fig 15

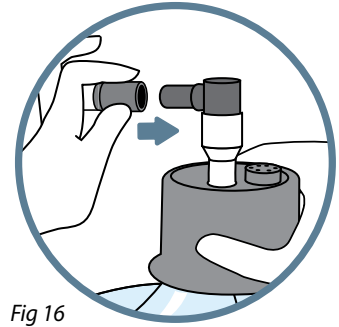

Fig 16

16. Wearing gloves, carefully unpack the new bottle adaptor. Pull the adaptor tube to straighten (Fig 14) and insert it into a new water bottle.
17. Feed the tube into the water bottle until it reaches the bottom.

18. Remove the red protective cap from the bottle tube (Fig 15). Install it into the bottle adaptor (Fig 16).
19. Slide water bottle into the cabinet and close the door.
20. Clean spigots, bottle receptacle and cabinet with 70% rubbing alcohol or food surface approved disinfecting wipes. Vacuum or wipe the grill on the back of the dispenser to remove any dust.

 **TIP: The cooler exterior should be cleaned every 6 months.**

21. Clean the drip tray and grill by emptying the tray and cleaning the tray and grill with dishwashing soap or by placing them on the top rack of the dishwasher (Fig 17).

 **TIP: The drip tray and grill should be cleaned monthly.**

22. Wipe down the cooler and the surrounding area to dry any water spills.
23. Wash your hands thoroughly with soap and water for at least 20 seconds.
24. Prime the dispenser to fill the reservoir by holding down the cold water spigot for 1 minute, or until water flows continuously. Repeat with the hot water spigot until water flows continuously. **Turn on the hot tank switch located under the front door top right.**



Fig 17

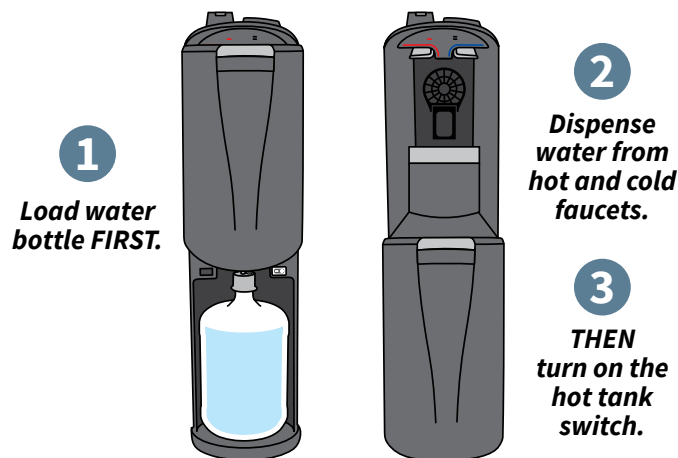

 **WARNING: Dispense water through the hot and cold spigots before turning on the hot tank switch. Failure to follow proper installation instructions may cause damage to water dispenser.**

## TROUBLESHOOTING

**⚠ WARNING: Always turn off dispenser and unplug from power outlet before inspecting or starting any maintenance.**

### WATER IS LEAKING

- Bottle may have a leak. Remove and install new bottle.
- If water is present only at base of unit (not dripping from above), first try to replace the water bottle.
- If water is leaking from above the bottle (or not bottle related), unplug dispenser and remove bottle. Check water connections and hose connections for holes, cracks or cuts.

### WATER DOES NOT FLOW FROM DISPENSER

- Make sure bottle is not empty; if empty, replace bottle.
- Ensure that water selection lever is fully depressed.
- Inspect to see if there is a pinhole in the bottle; if so, replace bottle.
- Ensure hot/cold tanks have been primed (see priming of water system in HOW TO INSTALL AND USE).
- Ensure all SmartFlo™ tubing is free of any holes, cuts or cracks.
- Ensure SmartFlo™ locking knobs (in top) are securely locked in place.
- Ensure unit is plugged in.
- Make sure the tubing lock clip is securely snapped in place.

### WATER NOT HOT OR COLD ENOUGH

- Check to make sure dispenser is plugged in and the hot tank heater switch is turned on.
- A fuse may be blown or the circuit breaker may be tripped; if needed, replace fuse or reset breaker.
- Dispenser may be placed in direct sunlight or may be too close to a heat source. Try moving dispenser into a cool, shaded area.
- Ensure hot/cold tanks have been primed (see priming of water system in HOW TO INSTALL AND USE).
- Ensure SmartFlo™ locking knobs (in top) are securely locked in place.

### BREWED BEVERAGE OVERFLOWS INSIDE UNIT

**⚠ Note: Run water through the AquaBarista by completing a couple of brew cycles without a K-Cup® pod to ensure that the coffee pod holder is clean. If the unit continues to overflow outside the unit proceed to the next step.**

- Brewer mechanism may be clogged. Remove coffee pod holder assembly and rinse thoroughly or wash in top rack of dishwasher.
- Always remove K-Cup® pods from unit after brewing. K-Cup® pods left in unit for extended periods can cause clogs.

**⚠ Note: If overflow occurred in the morning, recheck the AquaBarista in the afternoon. If overflow occurred in the afternoon, recheck the AquaBarista in the morning. This will allow time for the printed circuit board to dry.**

### BREWER NOT WORKING

- Ensure only Keurig brand K-Cup® pods are used. Subtle design differences in other pods can impede or prevent brewing.
- Remove K-Cup® pod from unit and check bottom of pod for puncture. If it is not punctured, return it to unit and press it firmly down into the coffee pod holder assembly to ensure complete contact with the unit's bottom needle.

## DISPENSER NEEDS TO BE STORED

- Always drain water completely from dispenser before shipping or storing.

 **NOTE:** Water left in the dispenser can freeze, damaging the dispenser.

 **IMPORTANT:** The customer acknowledges that water, like other liquids, can cause damage to surfaces. The customer takes full responsibility for placing the dispenser within a residence or business and acknowledges that failure to address drips, leaks or spillages is at the customer's risk.

 **WARNING:** *The Limited 1-Year Warranty and Underwriters' Laboratory and CE listings for the dispensers are invalidated if any alterations, modifications, or use or misuse in combination with any other machines or devices is deemed to be the source of any claim. See warranty document for complete terms and conditions. Primo Water North America accepts no liability (including for bodily injury) resulting from any alterations, misuse, neglect, accidents, improper installations or repairs. The appliance is not intended for use by persons (including children) with reduced physical, sensory or mental capabilities, or lack of experience and knowledge, without supervision by a person responsible for their safety.*